



Grayhill, Inc.

62S11-L9-PH

Número de pieza:

62S11-L9-PH

Fabricante / Marca:

Grayhill, Inc.

Descripción del producto

ROTARY ENCODER OPTICAL 32PPR

Hojas de datos:

 62S11-L9-PH.pdf

Estado de RoHS

 Sin plomo / Cumple con RoHS

Condición de stock

1972 pcs stock

Nave de

Hong Kong

Manera del envío

DHL/Fedex/TNT/UPS/EMS

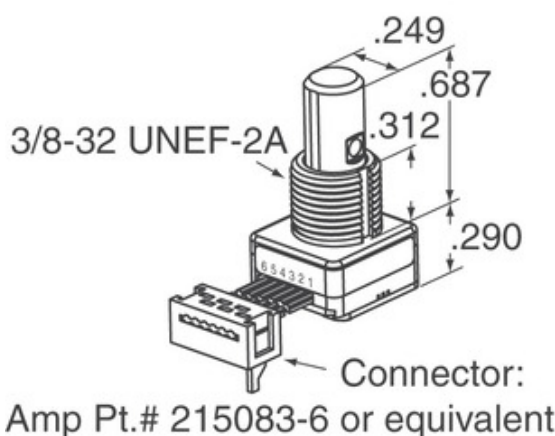

La imagen puede ser representación. Ver especificaciones para detalles del producto.

[SOLICITUD DE PRESUPUESTO](#)







Especificaciones de 62S11-L9-PH

NÚMERO DE PIEZA	62S11-L9-PH
FABRICANTE	Grayhill, Inc.
DESCRIPCIÓN	ROTARY ENCODER OPTICAL 32PPR
ESTADO LIBRE DE PLOMO / ESTADO ROHS	Sin plomo / Cumple con RoHS
CANTIDAD DISPONIBLE	1972 pcs
FICHA DE DATOS	 62S11-L9-PH.pdf
SUMINISTRO DE VOLTAJE	5V
ESTILO DE TERMINACIÓN	PC Pin
SERIE	62S
VIDA DE ROTACIÓN (CICLOS POR MINUTOS)	1M
PULSOS POR REVOLUCIÓN	32
TIPO DE SALIDA	Quadrature (Incremental)
OTROS NOMBRES	62S11L9PH
ORIENTACIÓN	Vertical
TIPO DE MONTAJE	PCB, Through Hole
NIVEL DE SENSIBILIDAD A LA HUMEDAD (MSL)	1 (Unlimited)
ESTADO SIN PLOMO / ESTADO ROHS	Lead free / RoHS Compliant
TIPO DE CODIFICADOR	Optical
FIJADOR	Yes
INTERRUPTOR INCORPORADO	Yes
TIPO DE ACTUADOR	1/4" Dia Flatted End

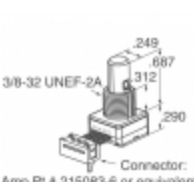
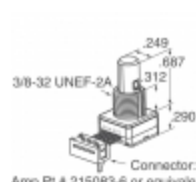
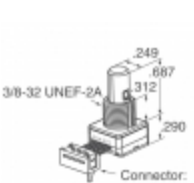
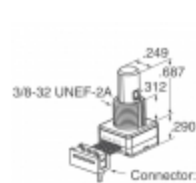
Tags relacionados

Grayhill, Inc. 62S11-L9-PH	Distribuidor 62S11-L9-PH	Proveedor 62S11-L9-PH
Precio 62S11-L9-PH	62S11-L9-PH Imágenes	Imagen 62S11-L9-PH
Hoja de datos PDF 62S11-L9-PH	Descargar la hoja de datos de 62S11-L9-PH	Hoja de datos 62S11-L9-PH
62S11-L9-PH Stock	Comprar 62S11-L9-PH	Comprar Grayhill, Inc. 62S11-L9-PH
Grayhill, Inc. 62S11-L9-PH	Proveedor Grayhill, Inc.	Distribuidor Grayhill, Inc.
Grayhill, Inc. 62S11-L9-PH	Grayhill Inc. 62S11-L9-PH	

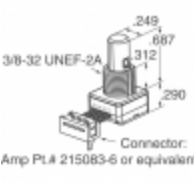
Productos relacionados

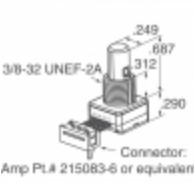
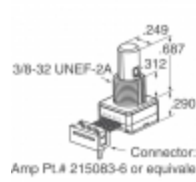
 <p>62S11-L9-020CH Fabricantes: Grayhill, Inc. Descripción: ROTARY ENCODER OPTICAL 32PPR En stock: 2264 pcs</p> <p>RFQ</p>	 <p>62S11-M0-030CH Fabricantes: Grayhill, Inc. Descripción: ROTARY ENCODER OPTICAL 32PPR En stock: 2151 pcs</p> <p>RFQ</p>
 <p>62S11-L9-040C Fabricantes: Grayhill, Inc. Descripción: ROTARY ENCODER OPTICAL 32PPR En stock: 1938 pcs</p> <p>RFQ</p>	 <p>62S11-L9-020C Fabricantes: Grayhill, Inc. Descripción: ROTARY ENCODER OPTICAL 32PPR En stock: 1773 pcs</p> <p>RFQ</p>
 <p>62S11-M0-040CH Fabricantes: Grayhill, Inc. Descripción: ROTARY ENCODER OPT 32PPR 2" CBL En stock: 1915 pcs</p> <p>RFQ</p>	 <p>62S11-M0-020SH Fabricantes: Grayhill, Inc. Descripción: ROTARY ENCODER OPT 32PPR 2" CBL En stock: 2051 pcs</p> <p>RFQ</p>
 <p>62S11-M0-050C Fabricantes: Grayhill, Inc. Descripción: ROTARY ENCODER OPT 32PPR 5" CBL En stock: 2292 pcs</p> <p>RFQ</p>	 <p>62S11-M0-060C Fabricantes: Grayhill, Inc. Descripción: ROTARY ENCODER OPT 32PPR 6" CBL En stock: 2289 pcs</p> <p>RFQ</p>
 <p>62S11-M0-020C Fabricantes: Grayhill, Inc. Descripción: ROTARY ENCODER OPT 32PPR 2" CBL En stock: 1812 pcs</p> <p>RFQ</p>	 <p>62S11-L5-PH Fabricantes: Grayhill, Inc. Descripción: ROTARY ENCODER OPTICAL 32PPR En stock: 2218 pcs</p> <p>RFQ</p>
 <p>62S11-L9-020SH Fabricantes: Grayhill, Inc. Descripción: ROTARY ENCODER OPTICAL 32PPR En stock: 1952 pcs</p> <p>RFQ</p>	 <p>62S11-L9-020S Fabricantes: Grayhill, Inc. Descripción: ROTARY ENCODER OPTICAL 32PPR En stock: 2134 pcs</p> <p>RFQ</p>

Copyright © 2020 Distribuidor confiable de componentes electrónicos

Email: Info@infinity-electronic.com

Dirección: 17F, Gaylord Commercial Building, 114-118 Lockhart Road, Wan Chai, Hong Kong

