



Grayhill, Inc.

62S11-M0-200S

Número de pieza:

62S11-M0-200S

Fabricante / Marca:

Grayhill, Inc.

Descripción del producto

ROTARY ENCODER OPTICAL 32PPR

Hojas de datos:

 62S11-M0-200S.pdf

Estado de RoHS

 Sin plomo / Cumple con RoHS

Condición de stock

2199 pcs stock

Nave de

Hong Kong

Manera del envío

DHL/Fedex/TNT/UPS/EMS

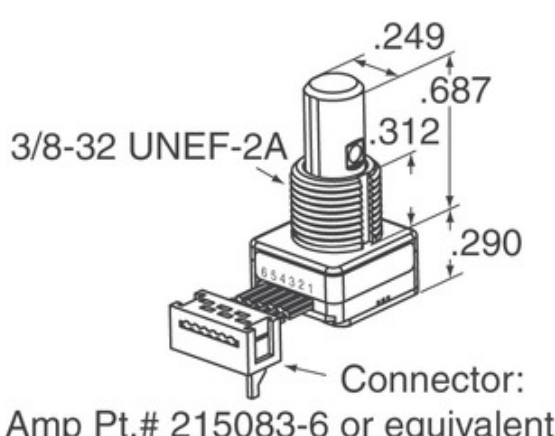

La imagen puede ser representación. Ver especificaciones para detalles del producto.

[SOLICITUD DE PRESUPUESTO](#)









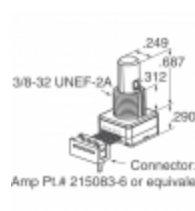
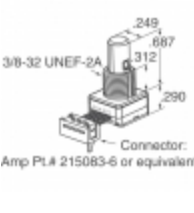

Especificaciones de 62S11-M0-200S

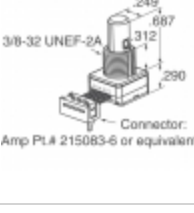
NÚMERO DE PIEZA	62S11-M0-200S
FABRICANTE	Grayhill, Inc.
DESCRIPCIÓN	ROTARY ENCODER OPTICAL 32PPR
ESTADO LIBRE DE PLOMO / ESTADO ROHS	Sin plomo / Cumple con RoHS
CANTIDAD DISPONIBLE	2199 pcs
FICHA DE DATOS	 62S11-M0-200S.pdf
SUMINISTRO DE VOLTAJE	5V
ESTILO DE TERMINACIÓN	Cable Leads
SERIE	62S
VIDA DE ROTACIÓN (CICLOS POR MINUTOS)	1M
PULSOS POR REVOLUCIÓN	32
TIPO DE SALIDA	Quadrature (Incremental)
OTROS NOMBRES	62S11M0200S
ORIENTACIÓN	Vertical
TIPO DE MONTAJE	Panel Mount
NIVEL DE SENSIBILIDAD A LA HUMEDAD (MSL)	1 (Unlimited)
ESTADO SIN PLOMO / ESTADO ROHS	Lead free / RoHS Compliant
TIPO DE CODIFICADOR	Optical
FIJADOR	Yes
INTERRUPTOR INCORPORADO	No
TIPO DE ACTUADOR	1/4" Dia Flatted End

Tags relacionados

Grayhill, Inc. 62S11-M0-200S	Distribuidor 62S11-M0-200S	Proveedor 62S11-M0-200S
Precio 62S11-M0-200S	62S11-M0-200S Imágenes	Imagen 62S11-M0-200S
Hoja de datos PDF 62S11-M0-200S	Descargar la hoja de datos de 62S11-M0-200S	Hoja de datos 62S11-M0-200S
62S11-M0-200S Stock	Comprar 62S11-M0-200S	Comprar Grayhill, Inc. 62S11-M0-200S
Grayhill, Inc. 62S11-M0-200S	Proveedor Grayhill, Inc.	Distribuidor Grayhill, Inc.
Grayhill, Inc. 62S11-M0-200S	Grayhill Inc. 62S11-M0-200S	

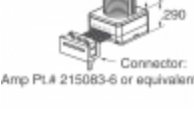
Productos relacionados

 <p>62S11-M0-060C Fabricantes: Grayhill, Inc. Descripción: ROTARY ENCODER OPT 32PPR 6" CBL En stock: 2289 pcs</p> <p>RFQ</p>	 <p>62S11-M0-030CH Fabricantes: Grayhill, Inc. Descripción: ROTARY ENCODER OPTICAL 32PPR En stock: 2151 pcs</p> <p>RFQ</p>
 <p>62S11-M0-020SH Fabricantes: Grayhill, Inc. Descripción: ROTARY ENCODER OPT 32PPR 2" CBL En stock: 2051 pcs</p> <p>RFQ</p>	 <p>62S11-M0-050C Fabricantes: Grayhill, Inc. Descripción: ROTARY ENCODER OPT 32PPR 5" CBL En stock: 2292 pcs</p> <p>RFQ</p>
 <p>62S11-M0-PH Fabricantes: Grayhill, Inc. Descripción: ROTARY ENCODER OPTICAL 32PPR En stock: 2503 pcs</p> <p>RFQ</p>	 <p>62S11-M0-210SH Fabricantes: Grayhill, Inc. Descripción: ROTARY ENCODER OPT 32PPR 20" CBL En stock: 2126 pcs</p> <p>RFQ</p>
 <p>62S11-M5-020C Fabricantes: Grayhill, Inc. Descripción: ROTARY ENCODER OPT 32PPR 2" CBL En stock: 2181 pcs</p> <p>RFQ</p>	 <p>62S11-M0-040CH Fabricantes: Grayhill, Inc. Descripción: ROTARY ENCODER OPT 32PPR 2" CBL En stock: 1915 pcs</p> <p>RFQ</p>
 <p>62S11-M0-060CH Fabricantes: Grayhill, Inc. Descripción: ROTARY ENCODER OPTICAL 32PPR En stock: 1968 pcs</p> <p>RFQ</p>	 <p>62S11-M0-P Fabricantes: Grayhill, Inc. Descripción: ROTARY ENCODER OPTICAL 32PPR En stock: 1933 pcs</p> <p>RFQ</p>
 <p>62S11-M0-PV Fabricantes: Grayhill, Inc. Descripción: ROTARY ENCODER OPTICAL 32PPR En stock: 2105 pcs</p> <p>RFQ</p>	 <p>62S11-M5-020CH Fabricantes: Grayhill, Inc. Descripción: ROTARY ENCODER OPTICAL 32PPR En stock: 1977 pcs</p> <p>RFQ</p>

Copyright © 2020 Distribuidor confiable de componentes electrónicos

Email: Info@infinity-electronic.com

Dirección: 17F, Gaylord Commercial Building, 114-118 Lockhart Road, Wan Chai, Hong Kong

