



Grayhill, Inc.

## 62S11-M5-030C

Número de pieza:

62S11-M5-030C

Fabricante / Marca:

Grayhill, Inc.

Descripción del producto

ROTARY ENCODER OPTICAL 32PPR

Hojas de datos:

 62S11-M5-030C.pdf

Estado de RoHS

 Sin plomo / Cumple con RoHS

Condición de stock

2076 pcs stock

Nave de

Hong Kong

Manera del envío

DHL/Fedex/TNT/UPS/EMS

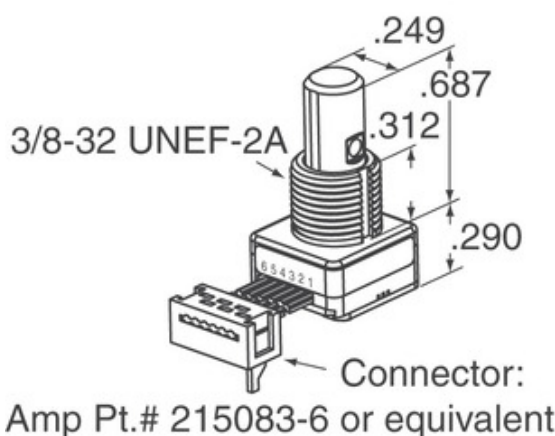

La imagen puede ser representación. Ver especificaciones para detalles del producto.

[SOLICITUD DE PRESUPUESTO](#)







### Especificaciones de 62S11-M5-030C

NÚMERO DE PIEZA	62S11-M5-030C
FABRICANTE	Grayhill, Inc.
DESCRIPCIÓN	ROTARY ENCODER OPTICAL 32PPR
ESTADO LIBRE DE PLOMO / ESTADO ROHS	Sin plomo / Cumple con RoHS
CANTIDAD DISPONIBLE	2076 pcs
FICHA DE DATOS	 62S11-M5-030C.pdf
SUMINISTRO DE VOLTAJE	5V
ESTILO DE TERMINACIÓN	Cable with Connector
SERIE	62S
VIDA DE ROTACIÓN (CICLOS POR MINUTOS)	1M
PULSOS POR REVOLUCIÓN	32
TIPO DE SALIDA	Quadrature (Incremental)
OTROS NOMBRES	62S11M5030C
ORIENTACIÓN	Vertical
TIPO DE MONTAJE	Panel Mount
NIVEL DE SENSIBILIDAD A LA HUMEDAD (MSL)	1 (Unlimited)
ESTADO SIN PLOMO / ESTADO ROHS	Lead free / RoHS Compliant
TIPO DE CODIFICADOR	Optical
FIJADOR	Yes
INTERRUPTOR INCORPORADO	Yes
TIPO DE ACTUADOR	1/4" Dia Flatted End

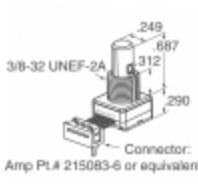
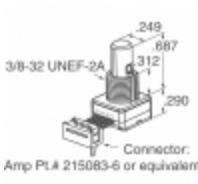
### Tags relacionados

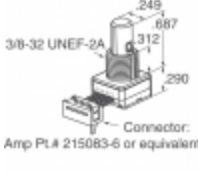
Grayhill, Inc. 62S11-M5-030C	Distribuidor 62S11-M5-030C	Proveedor 62S11-M5-030C
Precio 62S11-M5-030C	62S11-M5-030C Imágenes	Imagen 62S11-M5-030C
Hoja de datos PDF 62S11-M5-030C	Descargar la hoja de datos de 62S11-M5-030C	Hoja de datos 62S11-M5-030C
62S11-M5-030C Stock	Comprar 62S11-M5-030C	Comprar Grayhill, Inc. 62S11-M5-030C
Grayhill, Inc. 62S11-M5-030C	Proveedor Grayhill, Inc.	Distribuidor Grayhill, Inc.
Grayhill, Inc. 62S11-M5-030C	Grayhill Inc. 62S11-M5-030C	

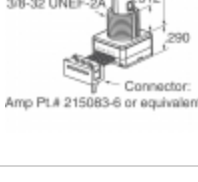
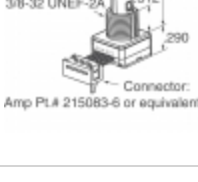
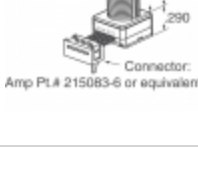
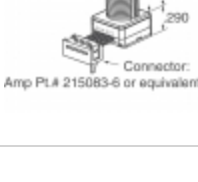
### Productos relacionados

 <p><b>62S11-M0-PH</b> Fabricantes: Grayhill, Inc. Descripción: ROTARY ENCODER OPTICAL 32PPR En stock: 2503 pcs</p> <p><a href="#">RFQ</a></p>	 <p><b>62S11-M0-PV</b> Fabricantes: Grayhill, Inc. Descripción: ROTARY ENCODER OPTICAL 32PPR En stock: 2105 pcs</p> <p><a href="#">RFQ</a></p>
 <p><b>62S11-M5-050C</b> Fabricantes: Grayhill, Inc. Descripción: ROTARY ENCODER OPT 32PPR 5" CBL En stock: 3137 pcs</p> <p><a href="#">RFQ</a></p>	 <p><b>62S11-M5-020S</b> Fabricantes: Grayhill, Inc. Descripción: ROTARY ENCODER OPTICAL 32PPR En stock: 2069 pcs</p> <p><a href="#">RFQ</a></p>
 <p><b>62S11-M5-060C</b> Fabricantes: Grayhill, Inc. Descripción: ROTARY ENCODER OPT 32PPR 6" CBL En stock: 2178 pcs</p> <p><a href="#">RFQ</a></p>	 <p><b>62S11-M5-020C</b> Fabricantes: Grayhill, Inc. Descripción: ROTARY ENCODER OPT 32PPR 2" CBL En stock: 2181 pcs</p> <p><a href="#">RFQ</a></p>
 <p><b>62S11-M5-040C</b> Fabricantes: Grayhill, Inc. Descripción: ROTARY ENCODER OPTICAL 32PPR En stock: 2150 pcs</p> <p><a href="#">RFQ</a></p>	 <p><b>62S11-M5-060CH</b> Fabricantes: Grayhill, Inc. Descripción: ROTARY ENCODER OPTICAL 32PPR En stock: 2064 pcs</p> <p><a href="#">RFQ</a></p>
 <p><b>62S11-M5-020CH</b> Fabricantes: Grayhill, Inc. Descripción: ROTARY ENCODER OPTICAL 32PPR En stock: 1977 pcs</p> <p><a href="#">RFQ</a></p>	 <p><b>62S11-M5-020SH</b> Fabricantes: Grayhill, Inc. Descripción: ROTARY ENCODER OPT 32PPR 2" CBL En stock: 1912 pcs</p> <p><a href="#">RFQ</a></p>
 <p><b>62S11-M5-055C</b> Fabricantes: Grayhill, Inc. Descripción: ROTARY ENCODER OPTICAL 32PPR En stock: 2056 pcs</p> <p><a href="#">RFQ</a></p>	 <p><b>62S11-M5-030CH</b> Fabricantes: Grayhill, Inc. Descripción: ROTARY ENCODER OPTICAL 32PPR En stock: 1862 pcs</p> <p><a href="#">RFQ</a></p>

Copyright © 2020 Distribuidor confiable de componentes electrónicos

Email: Info@infinity-electronic.com

Dirección: 17F, Gaylord Commercial Building, 114-118 Lockhart Road, Wan Chai, Hong Kong

