



Grayhill, Inc.

**62S11-N5-040C**

Número de pieza:

62S11-N5-040C

Fabricante / Marca:

Grayhill, Inc.

Descripción del producto

ROTARY ENCODER OPTICAL 32PPR

Hojas de datos:

 62S11-N5-040C.pdf

Estado de RoHS

 Sin plomo / Cumple con RoHS

Condición de stock

2106 pcs stock

Nave de

Hong Kong

Manera del envío

DHL/Fedex/TNT/UPS/EMS

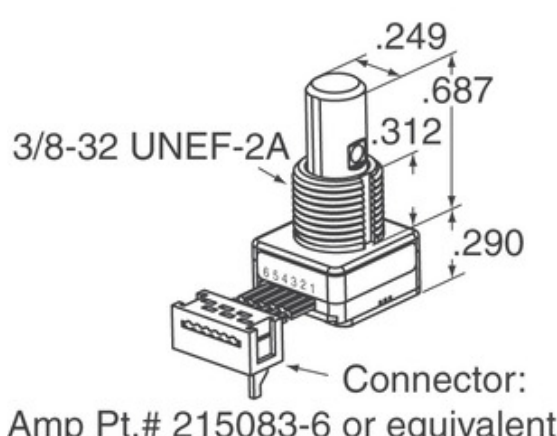

La imagen puede ser representación. Ver especificaciones para detalles del producto.

[SOLICITUD DE PRESUPUESTO](#)





## Especificaciones de 62S11-N5-040C

NÚMERO DE PIEZA	62S11-N5-040C
FABRICANTE	Grayhill, Inc.
DESCRIPCIÓN	ROTARY ENCODER OPTICAL 32PPR
ESTADO LIBRE DE PLOMO / ESTADO ROHS	Sin plomo / Cumple con RoHS
CANTIDAD DISPONIBLE	2106 pcs
FICHA DE DATOS	 62S11-N5-040C.pdf
SUMINISTRO DE VOLTAJE	5V
ESTILO DE TERMINACIÓN	Cable with Connector
SERIE	62S
VIDA DE ROTACIÓN (CICLOS POR MINUTOS)	1M
PULSOS POR REVOLUCIÓN	32
TIPO DE SALIDA	Quadrature (Incremental)
OTROS NOMBRES	62S11N5040C
ORIENTACIÓN	Vertical
TIPO DE MONTAJE	Panel Mount
NIVEL DE SENSIBILIDAD A LA HUMEDAD (MSL)	1 (Unlimited)
ESTADO SIN PLOMO / ESTADO ROHS	Lead free / RoHS Compliant
TIPO DE CODIFICADOR	Optical
FIJADOR	No
INTERRUPTOR INCORPORADO	Yes
TIPO DE ACTUADOR	1/4" Dia Flatted End

## Tags relacionados

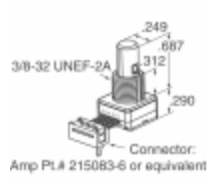
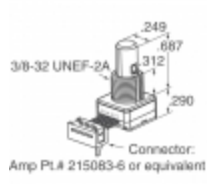
Grayhill, Inc. 62S11-N5-040C	Distribuidor 62S11-N5-040C	Proveedor 62S11-N5-040C
Precio 62S11-N5-040C	62S11-N5-040C Imágenes	Imagen 62S11-N5-040C
Hoja de datos PDF 62S11-N5-040C	Descargar la hoja de datos de 62S11-N5-040C	Hoja de datos 62S11-N5-040C
62S11-N5-040C Stock	Comprar 62S11-N5-040C	Comprar Grayhill, Inc. 62S11-N5-040C
Grayhill, Inc. 62S11-N5-040C	Proveedor Grayhill, Inc.	Distribuidor Grayhill, Inc.
Grayhill, Inc. 62S11-N5-040C	Grayhill Inc. 62S11-N5-040C	

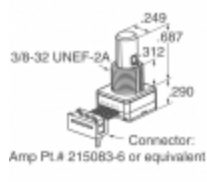
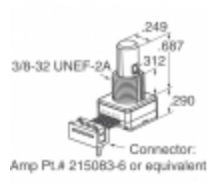
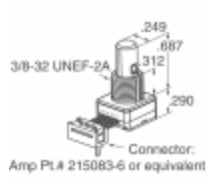
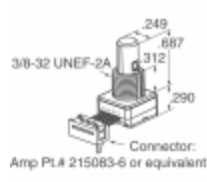
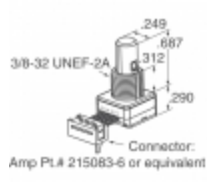
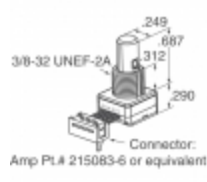
## Productos relacionados

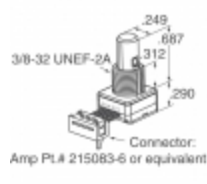
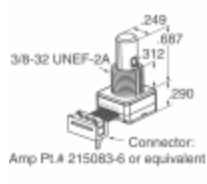
 <p><b>62S11-N4-060SH</b> Fabricantes: Grayhill, Inc. Descripción: ROTARY ENCODER OPTICAL 32PPR En stock: 2262 pcs</p> <p><a href="#">RFQ</a></p>	 <p><b>62S11-N5-060SH</b> Fabricantes: Grayhill, Inc. Descripción: ROTARY ENCODER OPTICAL 32PPR En stock: 2263 pcs</p> <p><a href="#">RFQ</a></p>
 <p><b>62S11-N5-025CH</b> Fabricantes: Grayhill, Inc. Descripción: ROTARY ENCODER OPTICAL 32PPR En stock: 2083 pcs</p> <p><a href="#">RFQ</a></p>	 <p><b>62S11-N4-P</b> Fabricantes: Grayhill, Inc. Descripción: ROTARY ENCODER OPTICAL 32PPR En stock: 1912 pcs</p> <p><a href="#">RFQ</a></p>
 <p><b>62S11-N5-060C</b> Fabricantes: Grayhill, Inc. Descripción: ROTARY ENCODER OPTICAL 32PPR En stock: 2164 pcs</p> <p><a href="#">RFQ</a></p>	 <p><b>62S11-N4-120S</b> Fabricantes: Grayhill, Inc. Descripción: ROTARY ENCODER OPTICAL 32PPR En stock: 2038 pcs</p> <p><a href="#">RFQ</a></p>
 <p><b>62S11-N5-050C</b> Fabricantes: Grayhill, Inc. Descripción: ROTARY ENCODER OPTICAL 32PPR En stock: 1936 pcs</p> <p><a href="#">RFQ</a></p>	 <p><b>62S11-N5-080SH</b> Fabricantes: Grayhill, Inc. Descripción: ROTARY ENCODER OPTICAL 32PPR En stock: 1942 pcs</p> <p><a href="#">RFQ</a></p>
 <p><b>62S11-N5-120S</b> Fabricantes: Grayhill, Inc. Descripción: ROTARY ENCODER OPTICAL 32PPR En stock: 1675 pcs</p> <p><a href="#">RFQ</a></p>	 <p><b>62S11-N5-025C</b> Fabricantes: Grayhill, Inc. Descripción: ROTARY ENCODER OPTICAL 32PPR En stock: 2408 pcs</p> <p><a href="#">RFQ</a></p>
 <p><b>62S11-N5-100C</b> Fabricantes: Grayhill, Inc. Descripción: ROTARY ENCODER OPTICAL 32PPR En stock: 1789 pcs</p> <p><a href="#">RFQ</a></p>	 <p><b>62S11-N4-PH</b> Fabricantes: Grayhill, Inc. Descripción: ROTARY ENCODER OPTICAL 32PPR En stock: 1970 pcs</p> <p><a href="#">RFQ</a></p>

Copyright © 2020 Distribuidor confiable de componentes electrónicos

Email: Info@infinity-electronic.com

Dirección: 17F, Gaylord Commercial Building, 114-118 Lockhart Road, Wan Chai, Hong Kong

