



Key Specifications

- Flexible Multi-Profile Audio Bluetooth development kit
- Dual Mode Bluetooth and Bluetooth Low Energy
- Integrates BC127 module and Melody software
- Small form factor approx. 7.5cm by 5cm (3" by 2")
- Easy button control of Music (A2DP) and Voice (HFP) features
- Stereo Mic In/ Line In via 3.5mm jack plug
- Stereo Headphone Out via 3.5mm jack plug
- SPDIF, PCM, I2S, Differential Audio easy access headers
- PIO and I2C easy access headers
- Access to UART via USB (FTDI on board) or PIO header
- A2DP1.2, AVRCP1.4, HFP 1.6, PBAP, MAP, SPP 1.0
- Melody Data Service over BLE
- Supports aptX, AAC, SBC and MP3¹

Applications

- Audio devices
- Wireless speakers
- Music gateways
- Automotive multimedia systems
- Cable replacement

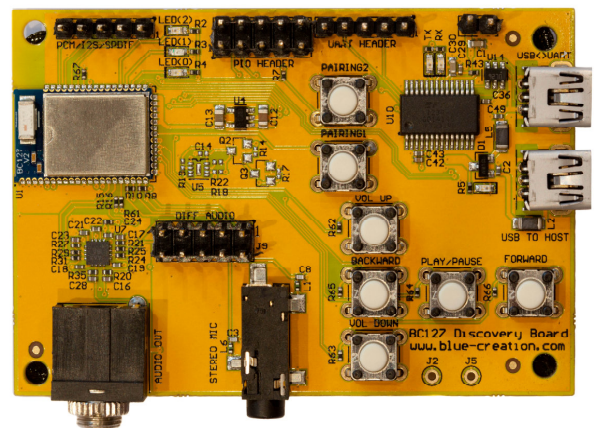

To Scale

Description

BC127-DISKIT-001 (Discovery Board) is a development board that allows hobbyists and engineers to quickly discover Bluetooth and prototype devices using Melody and high level commands. No detailed knowledge of the Bluetooth specification required!

It is the ideal kit to start working with Bluetooth!

¹ Only SBC is available to use free of charge. BC127 Discovery Board does not include an aptX licence and does not include MP3 and AAC royalty payments. Please contact the respective right holders to obtain those.



Getting Started (Connecting to a Phone)

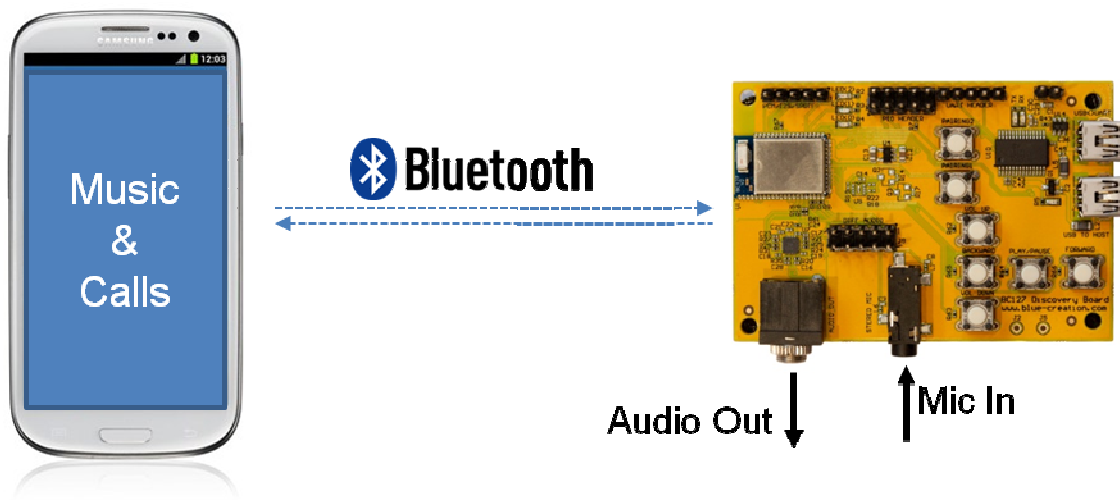

Setting up the BC127 Discovery Board

- 1) Connect the supplied USB cable to the USB TO UART plug on your board.
- 2) Plug in the USB into a USB charger or PC.
- 3) You should see a red LED next to the USB connector light up, and LED(0) and LED(1) will be alternating.
- 4) You are all set to go! You can now connect your headset to the board, connect to it from your phone and start streaming music and receiving calls. Read on to find out how.

Connecting from a phone (or other Bluetooth enabled device)

- 1) Enable Bluetooth on your device and start searching (often labeled as 'discovering') for devices.
- 2) You will be displayed all the discoverable Bluetooth devices around you.
- 3) Look for a device named "BlueCreation-XXXXXX", where X will be characters in the range 0 - 9 and A-F.
- 4) Press on the device or select 'Pair'. You may be asked to confirm this action.
- 5) Your device will tell you if pairing was successful and should then automatically connect to your BC127-DISKIT-001. If this does not happen, find the BlueCreation-XXXXXX device in the list of paired devices and manually connect.



- 6) Your Discovery Board will indicate that it is connected by lighting up LED(1).
- 7) You are now ready to listen to music and handle calls.

Listening to and Controlling Music on the BC127 Discovery Board

- 1) Assuming you are connected to your Discovery Board, plug in your headphones into the AUDIO OUT jack.
- 2) Open your music player and start playing music.
- 3) You should now hear music on your headset.
- 4) You can now adjust volume by using the VOL UP/VOL DOWN buttons, change tracks, and stop and start playback. Please see **Table 1** for full button functionality.

Voice Calls on the BC127 Discovery Board

If you are connected to your Discovery Board with a phone, phone calls will automatically be routed to it.

- 1) Connect Headphones and a Microphone to the AUDIO OUT and STEREO MIC jacks on your Discovery Board. If you have an incoming phone call, music streaming will stop and you will hear your ringtone.
- 2) Press the PLAY/PAUSE key to answer the call.
- 3) You can hang-up by pressing PLAY/PAUSE again.
- 4) To redial the last number dialed from your phone, you can double press PLAY/PAUSE.



Getting Started (Connecting to a Headset)

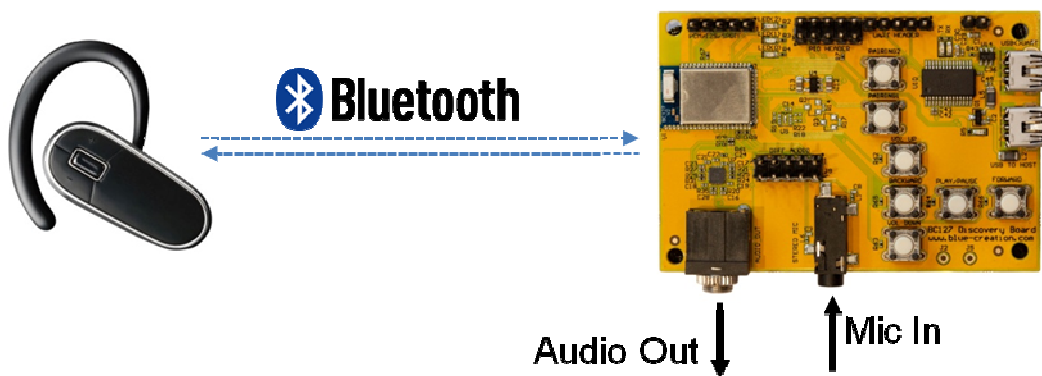

Setting up the BC127 Discovery Board

- 1) Connect the supplied USB cable to the USB TO HOST plug on your board.
 - 2) Plug in the USB into a USB charger or PC.
 - 3) You should see a red LED next to the USB connector light up, and LED(0) and LED(1) will be alternating.
 - 4) Make sure your headset is Discoverable (Pairable) and that it is the only device within a 3m radius of your Discovery Board.
 - 5) Double press on the VREG button. If this is the first time you are using your board, the Discovery Board will start searching for discoverable devices near you and connect to the first one found. If you have followed the instructions in 4, this should be your headset (LED (0) and (1) will be alternating).
- If you have previously paired your Discovery Board to any devices, it will try to reconnect to those devices (LED(1) will be blinking), and if that fails, it will start searching for discoverable devices to pair with.
- 5) A solid light on LED(2) indicates that your Discovery board has connected. You are now ready!

Streaming music to Bluetooth Headsets and Speakers

- 1) Connect your audio device to your Discovery Board using the STEREO MIC jack
- 2) Press PLAY/PAUSE to start audio streaming to your wireless headset or speakers.
- 3) You can adjust volume using the VOL UP/VOL DOWN buttons, and you can toggle the music stream on or off using the PLAY/PAUSE button.



Voice Calls with the BC127 Discovery Board

- 1) Connect Headphones and a Microphone to the AUDIO OUT and STEREO MIC jack plugs on your Discovery Board. If you have an incoming phone call, music streaming will stop and you will hear your ringtone.
- 2) You can use the Redial command from you headset to establish a call. Alternatively, you can double press PLAY/PAUSE.
- 3) During a call, you can hang-up by pressing PLAY/PAUSE again.



Getting Started (2 boards)

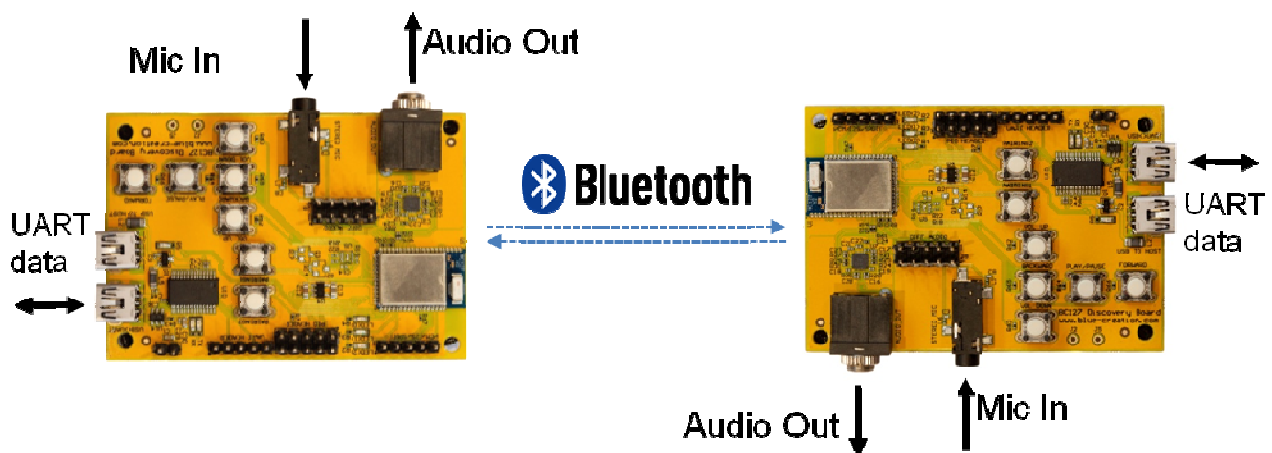

You can use two BC127 Discovery Boards and have them connect to each other establishing a closed system that supports music streaming, voice calls, and bidirectional transparent UART forwarding.

Setting up the BC127 Discovery Boards

- 1) Connect the supplied USB cable to the USB TO HOST plug on both boards. For UART forwarding, please follow the instructions in **Setting Up UART Forwarding and Control** and go to step 3 below.
- 2) Power the Discovery boards by connecting the USB cables to two PC or USB power supplies.
- 3) On both boards, you should see a red LED next to the USB connector light up, and LED(0) and LED(1) will be alternating.
- 4) Select one of the boards to be Source.
- 5) Ensure that there are no other Bluetooth devices discoverable within a 3m radius from your designated Source board.
- 6) Ensure your other board is within a 3m radius from your Source board.
- 7) On your designated Source board, double press on the VREG button. If this is the first time you are using your board, the Discovery Board will start searching for discoverable devices near you and connect to the first one found. If you have followed the instructions in 4, this should be your headset, (LED (0) and (1) will be alternating).

If you have previously paired your Discovery Board to any devices, it will try to reconnect to those devices



(LED(1) will be blinking), and if that fails, it will start searching for discoverable devices to pair with.

8) A solid light on LED(0) indicates that your Source Discovery Board has connected. A solid LED(1) will indicate your Sink (headset) board is connected. You are now ready!

Streaming music between your BC127 Discovery Boards

- 1) Connect your audio device to your Source Discovery Board using the STEREO MIC jack plugs.
- 2) Connect your headset to your Sink Discovery Board using the AUDIO OUT jack plugs.
- 3) Press PLAY/PAUSE on either device to start music streaming. Press PLAY/PAUSE again to stop it.
- 4) You can adjust volume using the VOL UP/VOL DOWN buttons.

Establishing a voice call between your BC127 Discovery Boards

- 1) Connect a headset to the AUDIO OUT and microphone to the STEREO MIC jack plugs of both boards.
- 2) Double press on PLAY/PAUSE on either board to start a voice call, and single press during an active call to close it.
- 3) You can adjust volume using the VOL UP/VOL DOWN buttons.



Sending data between your BC127 Discovery Boards

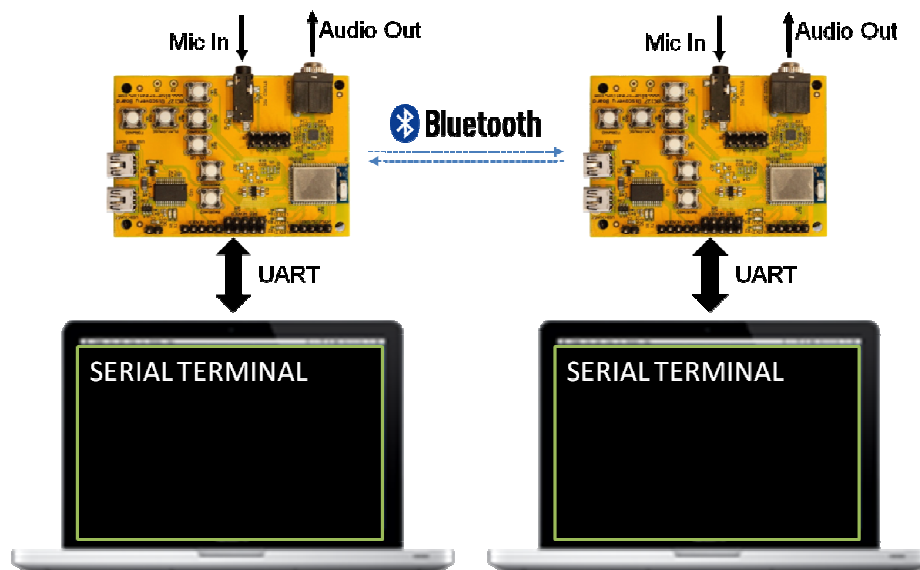

- 1) Assuming you have successfully set up the boards to use a UART connection, open a serial terminal for each board.
- 2) Type any character and you should see it displayed on the other side.
- 3) You can use the buttons to start audio streaming or voice calls while sending data between your Discovery boards.



Setting Up UART Forwarding and Control

To start you need to have:

- A PC or any other computer with a USB port.
- A serial terminal such as HyperTerminal or PuTTY installed on your computer. You can use any on you prefer, these are two common free options:
 - PuTTY: <http://www.chiark.greenend.org.uk/~sgtatham/putty/>
 - Hercules HyperTerminal: http://www.hw-group.com/products/hercules/index_en.html

Setting up the BC127 Discovery Board

1) Connect the board to your PC using the USB cable. Plug in the USB cable into your computer and into the Discovery board in the USB plug labeled "USB<>UART". The board will enumerate as an FT232R USB UART Interface. Your computer should automatically find and install the required FTDI drivers.²

2) Go to StartUp/Devices and Printers. You will see your board will be under FT232R USB UART. When you look at Properties you will see under which COM port it has enumerated.

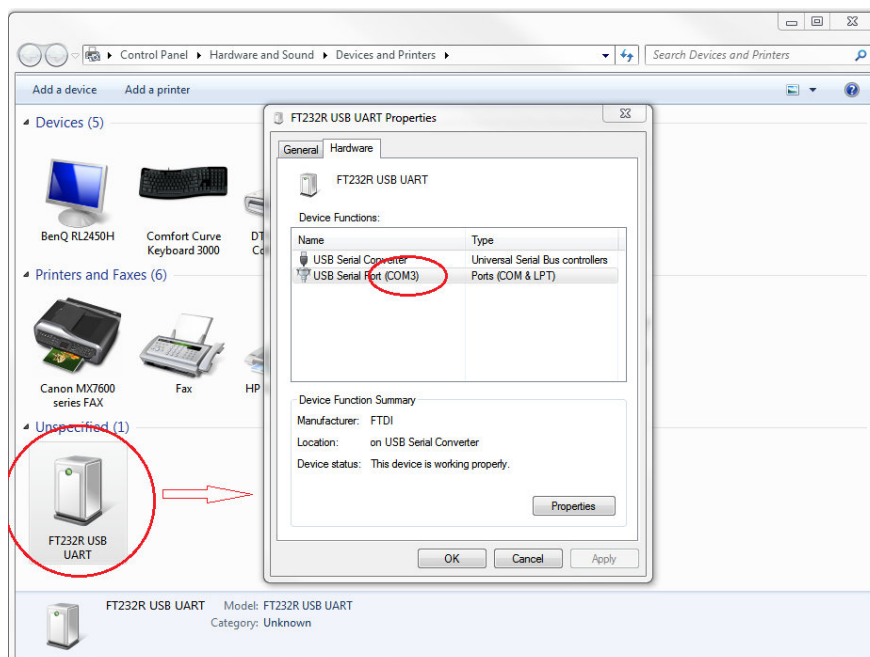

Fig. 1: Correct USB COM port enumeration on a PC. Please note your COM port number may differ.

² Ensure you have sufficient user privileges to install devices on your system.



3) Launch your chosen serial terminal utility. Please use the following parameters for the UART settings (these are the default settings).

- Baud rate : 9600bps
- Data bits : 8
- Stop bits : 1
- Parity bit : No parity
- HW Flow Control : Disabled

Ensure that when you type 'RETURN/ENTER' no additional characters (such as a line feed) are sent. This is usually under the line endings setting of your serial terminal application. If you are using PuTTY you do not need to change anything, however, please refer to Fig. 2 below to confirm that this is set OK.

For your convenience, you may also wish to enable the "Local Echo" option. This will display what you have just typed into your terminal. Most terminal applications have this set to off by default. Please refer to Fig. 2 below on how to set this on for PuTTY.

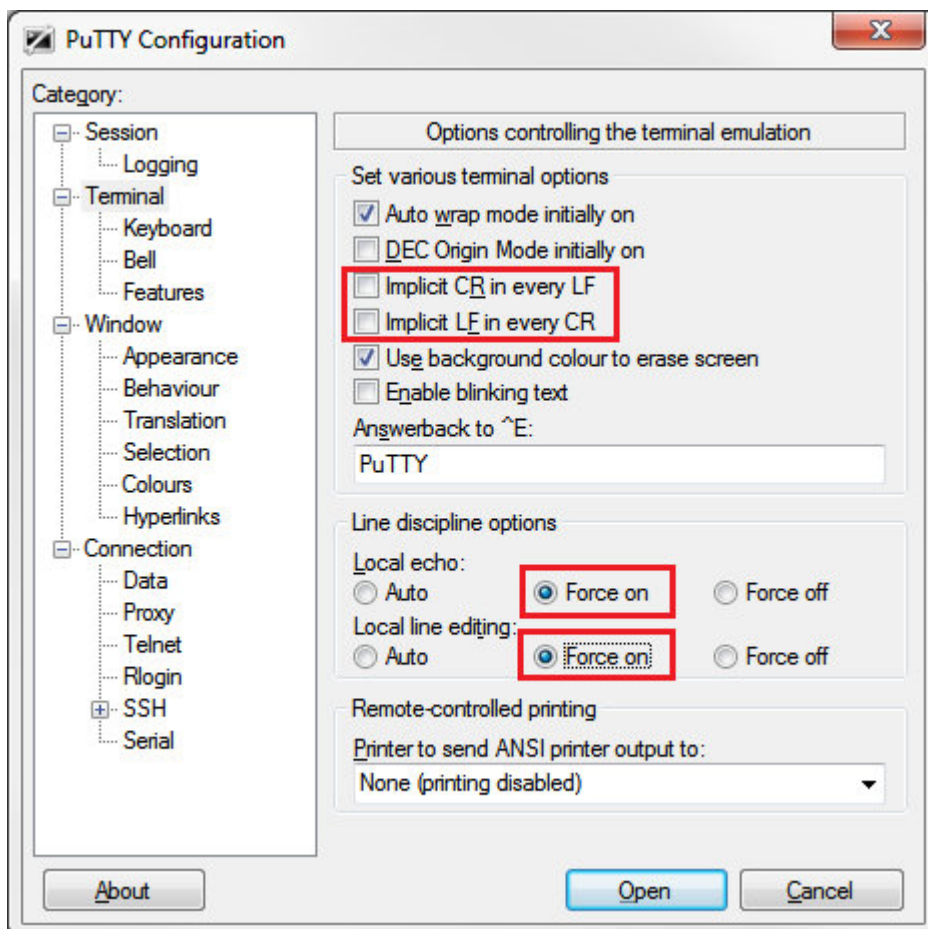

Fig. 2: PuTTY settings: Enabling 'Local Echo' and using correct line endings.



4) In your terminal window, type Reset and then press Enter. You should then see the BlueCreation Melody prompt. You are now ready to use the board.

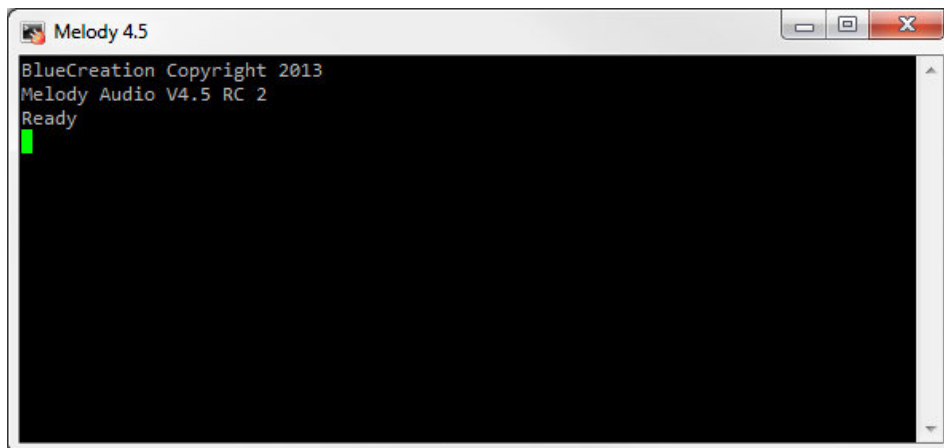

Fig. 3: Melody start prompt.

Controlling your BC127 Discovery Board

Please refer to the Melody Manual for more information on the different commands you can use to control the board.

If you do not have a copy of the Melody Manual, please contact info@bluecreation.com to request one.

Note that by default when a BC127 Discovery Board connects to SPP, it will go into transparent mode and no commands will be accepted, instead data will transparently be sent bi-directionally over UART. Please refer to Melody Manual for more information.



Board Button and Header Description

Button	PIO	Description
VREGEN single	-	If Source - disable source, store, reset and become discoverable. If Sink - disconnect any active connections and become discoverable.
VREGEN double	-	Enable Source mode and auto connection, store and reset. It will also start inquiry and pairing to the nearest headset when auto connect fails.
VOL UP single	0	Increases volume (separate levels for voice and music).
VOL DOWN single	1	Decreases volume (separate levels for voice and music).
PLAY/PAUSE single	2	Starts playing music or stop playing music. If there is an incoming voice call it will answer the call. During an ongoing call it will end the call.
PLAY/PAUSE double	2	Initiate a voice call.
BACKWARD single	4	Sends AVRCP instruction BACKWARD.
FORWARD single	5	Sends AVRCP instruction FORWARD (Next track).

Table 1: Button functions

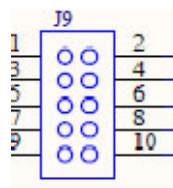
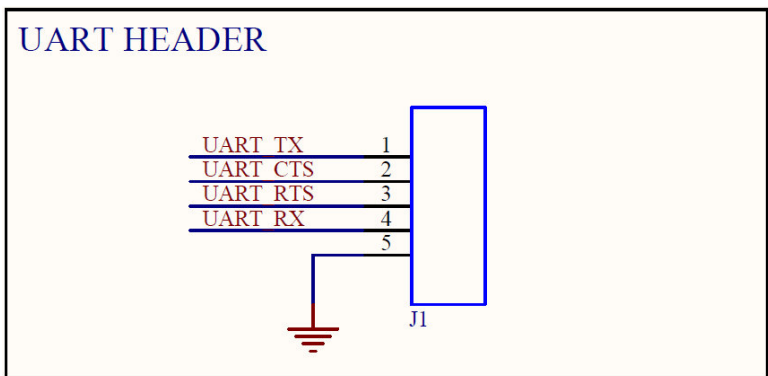
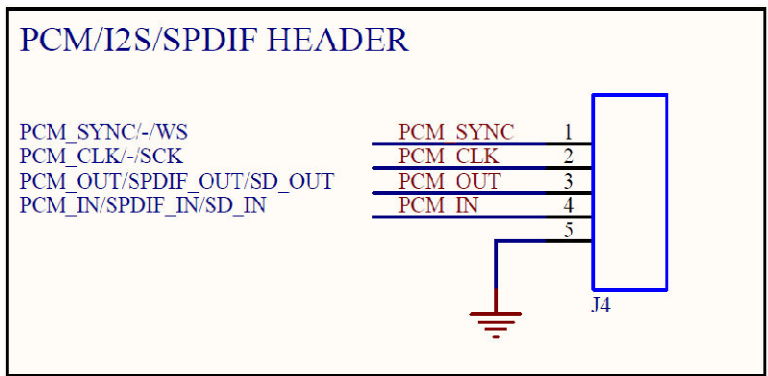
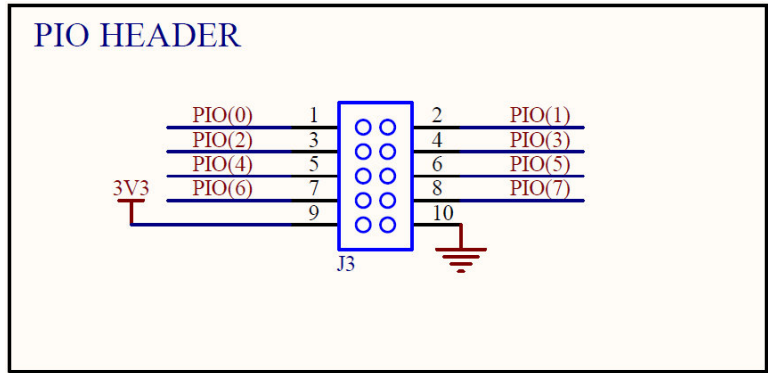

Fig. 4: Differential audio header

Function	Pin	Pin	Function
Left microphone positive input	1	2	Right microphone positive input
Left microphone negative input	3	4	Right microphone negative input
Left headphone positive output (unamplified)	5	6	Right headphone positive output (unamplified)
Left headphone negative output (unamplified)	7	8	Right headphone negative output (unamplified)
Microphone bias	9	10	Ground

Table 2: Differential audio header pin functions





Trouble-Shooting

If your board does not seem to work, please go through the most common problems below and the suggested troubleshooting steps. If you are still having issues, please contact techsupport@bluecreation.com.

Power:

If when you connect the USB cable your device does not start alternating LED(0) and LED(1) you may not be supplying power over USB.

Check the red LED next to the USB TO HOST connector on the board. If it is not lit up, you are not supplying power to the board. Try plugging into a different USB port or charger and then try a different cable.

FTDI Driver:

The PC usually automatically installs the USB FTDI drivers when you first plug in the board. If the drivers are not successfully installed, unplug the board and plug it into a different USB port. If that does not work please follow the steps in **FTDI Trouble-Shooting**

UART:

If your FTDI driver installed correctly but you do not see anything or you see garbage on your serial terminal, please check if your UART settings are as described in **Setting Up UART Forwarding and Control** .

Bluetooth:

If you want to connect to your board, make sure that the module is in discoverable state - LED(0) and LED(0) should be alternating. If this is not the case, single press on VREG. Alternatively, if you have UART connected, the STATUS command should return 'DISCOVERABLE CONNECTABLE'. If this is not the case, please type in 'DISCOVERABLE ON'. Refer to the Melody Manual for more information.



FTDI Trouble-Shooting

Drive Update and Reinstallation

If the device has not enumerated correctly or you may need to re-install the driver. This is done by going to Properties/Change Settings/Update Driver as in the figure above.

You can also try Properties/Change Settings/Un-install. When you plug the board back in, the PC will look on Internet for the drivers.

While Windows should find the latest version of the driver for your system, you may want to go to the FTDI website and download and install the latest drivers yourself: <http://www.ftdichip.com/Drivers/VCP.htm>

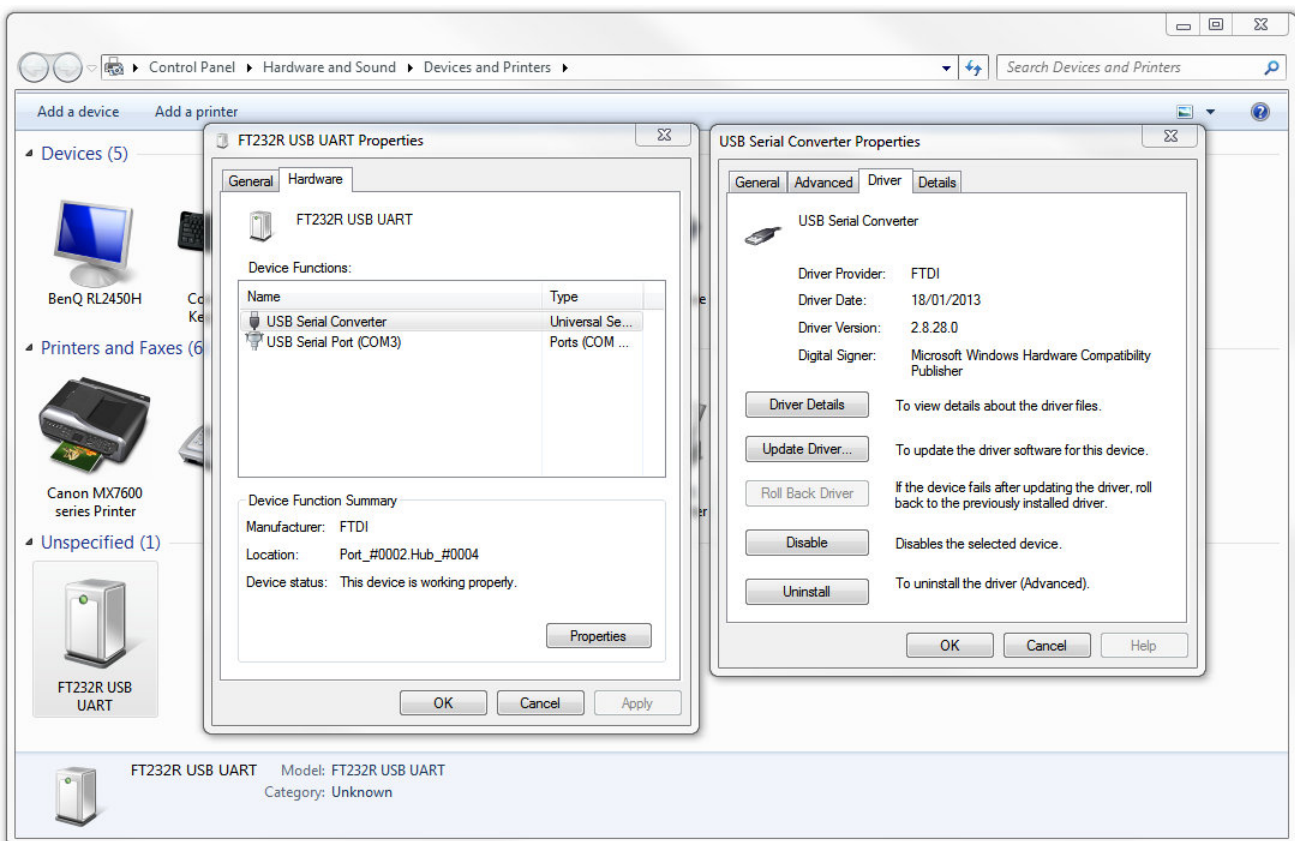

Fig. 5: Driver Update for FTDI



Driver Cleaning

If you need to clean a previous install of the FTDI driver from your system and/or clear any COM Ports added to the registry then you should obtain the CDM Uninstaller from the following link:

http://www.ftdichip.com/Support/Utilities/CDMUninstaller_v1.4.zip

Extract the contents of this ZIP file into a folder on your desktop or elsewhere and run the CDMuninstallerGUI.exe file.

You should see the following dialogue box which already has the FT232R Product/Vendor IDs in the box.

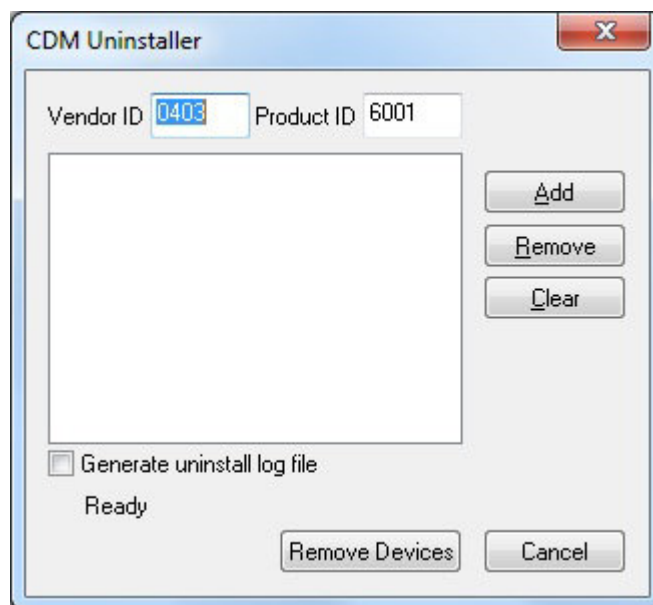

Fig. 6: CDM Uninstaller Load Screen

Click the "Add" button to add this Product/Vendor ID to the list of devices to remove. Optionally you can check the "Generate log file" checkbox for a record of what operations were performed and which COM Port entries were removed. Now press the "Remove Devices" button. Once completed you should restart your computer so that the O/S can clean things up. You should then be ready to re-install your drivers as listed above.

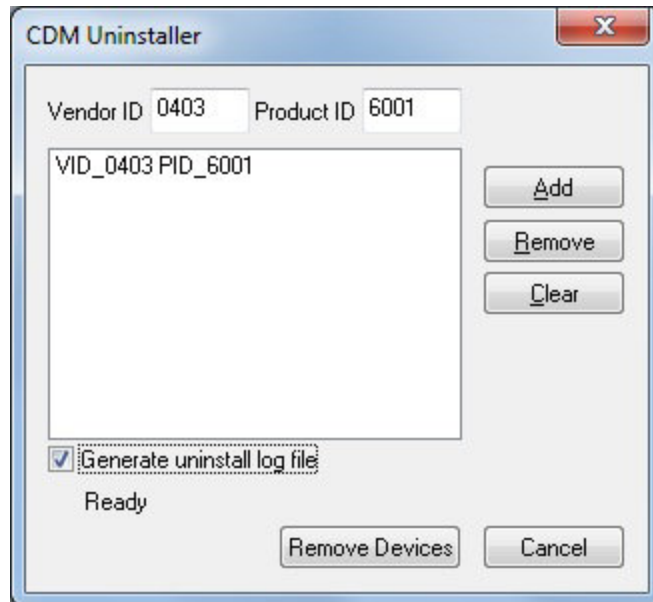

Fig. 7: CDM Uninstaller after FTDI Vendor and Product ID have successfully been added

Download the latest driver from the FTDI website at the following link:

<http://www.ftdichip.com/Drivers/VCP.htm>

When installing the driver, ensure you have sufficient user privileges to install devices on your computer.