



Grayhill, Inc.

62S11-L0-055C

Número de pieza:

62S11-L0-055C

Fabricante / Marca:

Grayhill, Inc.

Descripción del producto

ROTARY ENCODER OPTICAL 32PPR

Hojas de datos:

 62S11-L0-055C.pdf

Estado de RoHS

 Sin plomo / Cumple con RoHS

Condición de stock

1995 pcs stock

Nave de

Hong Kong

Manera del envío

DHL/Fedex/TNT/UPS/EMS

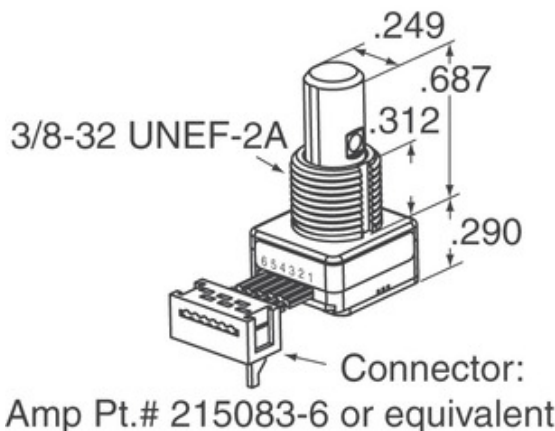

La imagen puede ser representación. Ver especificaciones para detalles del producto.

[SOLICITUD DE PRESUPUESTO](#)

Especificaciones de 62S11-L0-055C

NÚMERO DE PIEZA	62S11-L0-055C
FABRICANTE	Grayhill, Inc.
DESCRIPCIÓN	ROTARY ENCODER OPTICAL 32PPR
ESTADO LIBRE DE PLOMO / ESTADO ROHS	Sin plomo / Cumple con RoHS
CANTIDAD DISPONIBLE	1995 pcs
FICHA DE DATOS	 62S11-L0-055C.pdf
SUMINISTRO DE VOLTAJE	5V
ESTILO DE TERMINACIÓN	Cable with Connector
SERIE	62S
VIDA DE ROTACIÓN (CICLOS POR MINUTOS)	1M
PULSOS POR REVOLUCIÓN	32
TIPO DE SALIDA	Quadrature (Incremental)
OTROS NOMBRES	62S11L0055C
ORIENTACIÓN	Vertical
TIPO DE MONTAJE	Panel Mount
NIVEL DE SENSIBILIDAD A LA HUMEDAD (MSL)	1 (Unlimited)
ESTADO SIN PLOMO / ESTADO ROHS	Lead free / RoHS Compliant
TIPO DE CODIFICADOR	Optical
FIJADOR	Yes
INTERRUPTOR INCORPORADO	No
TIPO DE ACTUADOR	1/4" Dia Flatted End

Tags relacionados

Grayhill, Inc. 62S11-L0-055C	Distribuidor 62S11-L0-055C	Proveedor 62S11-L0-055C
Precio 62S11-L0-055C	62S11-L0-055C Imágenes	Imagen 62S11-L0-055C
Hoja de datos PDF 62S11-L0-055C	Descargar la hoja de datos de 62S11-L0-055C	Hoja de datos 62S11-L0-055C
62S11-L0-055C Stock	Comprar 62S11-L0-055C	Comprar Grayhill, Inc. 62S11-L0-055C
Grayhill, Inc. 62S11-L0-055C	Proveedor Grayhill, Inc.	Distribuidor Grayhill, Inc.
Grayhill, Inc. 62S11-L0-055C	Grayhill Inc. 62S11-L0-055C	

Productos relacionados

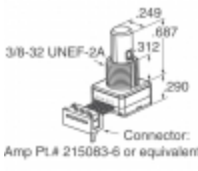
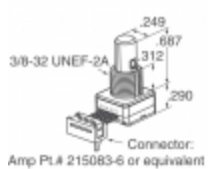
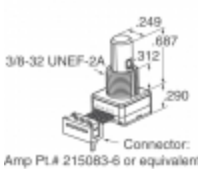
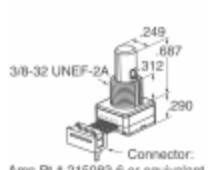
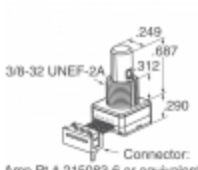
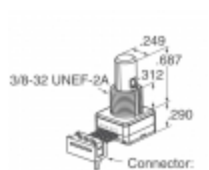
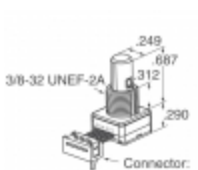
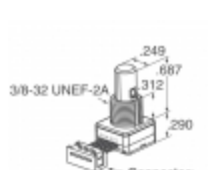
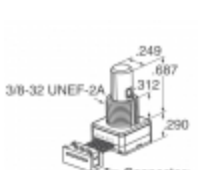
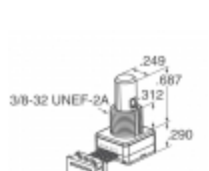
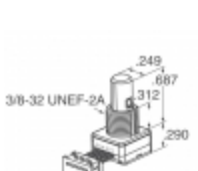
 <p>62S11-L0-040S Fabricantes: Grayhill, Inc. Descripción: ROTARY ENCODER OPT 32PPR 4" CBL En stock: 2058 pcs</p> <p>RFQ</p>	 <p>62S11-L0-020C Fabricantes: Grayhill, Inc. Descripción: ROTARY ENCODER OPTICAL 32PPR En stock: 1839 pcs</p> <p>RFQ</p>
 <p>62S11-L0-040C Fabricantes: Grayhill, Inc. Descripción: ROTARY ENCODER OPTICAL 32PPR En stock: 2079 pcs</p> <p>RFQ</p>	 <p>62S11-L0-PHV Fabricantes: Grayhill, Inc. Descripción: ROTARY ENCODER OPTICAL 32PPR En stock: 1991 pcs</p> <p>RFQ</p>
 <p>62S11-L0-PH Fabricantes: Grayhill, Inc. Descripción: ROTARY ENCODER OPTICAL 32PPR En stock: 2460 pcs</p> <p>RFQ</p>	 <p>62S11-L0-060S Fabricantes: Grayhill, Inc. Descripción: ROTARY ENCODER OPTICAL 32PPR En stock: 2241 pcs</p> <p>RFQ</p>
 <p>62S11-L0-020CH Fabricantes: Grayhill, Inc. Descripción: ROTARY ENCODER OPTICAL 32PPR En stock: 2105 pcs</p> <p>RFQ</p>	 <p>62S11-L0-060CH Fabricantes: Grayhill, Inc. Descripción: ROTARY ENCODER OPTICAL 32PPR En stock: 1935 pcs</p> <p>RFQ</p>
 <p>62S11-H9-PH Fabricantes: Grayhill, Inc. Descripción: ROTARY ENCODER OPTICAL 32PPR En stock: 2090 pcs</p> <p>RFQ</p>	 <p>62S11-H9-P Fabricantes: Grayhill, Inc. Descripción: ROTARY ENCODER OPTICAL 32PPR En stock: 2159 pcs</p> <p>RFQ</p>
 <p>62S11-L0-060SH Fabricantes: Grayhill, Inc. Descripción: ROTARY ENCODER OPTICAL 32PPR En stock: 2073 pcs</p> <p>RFQ</p>	 <p>62S11-L0-P Fabricantes: Grayhill, Inc. Descripción: ROTARY ENCODER OPTICAL 32PPR En stock: 2100 pcs</p> <p>RFQ</p>

Copyright © 2020 Distribuidor confiable de componentes electrónicos

Email: Info@infinity-electronic.com

Dirección: 17F, Gaylord Commercial Building, 114-118 Lockhart Road, Wan Chai, Hong Kong

