

Panasonic

Panasonic

TX2SA-L2-24V-1

Número de pieza:

TX2SA-L2-24V-1

Fabricante / Marca:

Panasonic

Descripción del producto

RELAY TELECOM DPDT 1A 220V

Hojas de datos:

Estado de RoHS

 Sin plomo / Cumple con RoHS

Condición de stock

15332 pcs stock

Nave de

Hong Kong

Manera del envío

DHL/Fedex/TNT/UPS/EMS

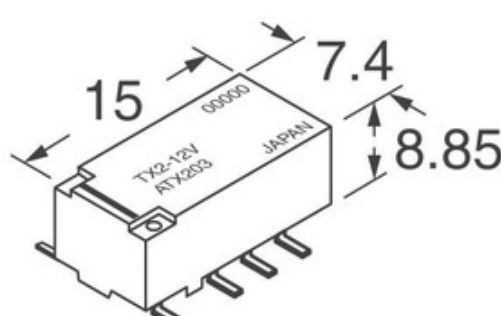

La imagen puede ser representación. Ver especificaciones para detalles del producto.

SOLICITUD DE PRESUPUESTO











Especificaciones de TX2SA-L2-24V-1

NÚMERO DE PIEZA	TX2SA-L2-24V-1
FABRICANTE	Panasonic
DESCRIPCIÓN	RELAY TELECOM DPDT 1A 220V
ESTADO LIBRE DE PLOMO / ESTADO ROHS	Sin plomo / Cumple con RoHS
CANTIDAD DISPONIBLE	15332 pcs
FICHA DE DATOS	
ACTIVAR VOLTAJE (MAX)	18 VDC
VOLTAJE DE APAGADO (MIN)	-
ESTILO DE TERMINACIÓN	Gull Wing
TENSIÓN DE CONMUTACIÓN	220VAC, 220VDC - Max
SERIE	TX
TIEMPO DE LIBERACIÓN	4ms
TIPO DE RELÉ	Telecom
EMBALAJE	Tube
OTROS NOMBRES	255-6236 TX2SA-L2-24V-1-ND
TEMPERATURA DE FUNCIONAMIENTO	-40°C ~ 85°C
TIEMPO DE FUNCIONAMIENTO	4ms
TIPO DE MONTAJE	Surface Mount
NIVEL DE SENSIBILIDAD A LA HUMEDAD (MSL)	4 (72 Hours)
ESTADO SIN PLOMO / ESTADO ROHS	Lead free / RoHS Compliant
CARACTERÍSTICAS	Sealed - Fully
DESCRIPCIÓN DETALLADA	Telecom Relay DPDT (2 Form C) Surface Mount
CLASIFICACIÓN DE CONTACTO (ACTUAL)	1A
MATERIAL DE LOS CONTACTOS	Silver Palladium (AgPd), Gold (Au)
FORMULARIO DE CONTACTO	DPDT (2 Form C)
VOLTAJE DE LA BOBINA	24VDC
TIPO DE BOBINA	Latching, Dual Coil
RESISTENCIA DE LA BOBINA	2.88 kOhms
POTENCIA DE LA BOBINA	200 mW
CORRIENTE DE LA BOBINA	8.3mA

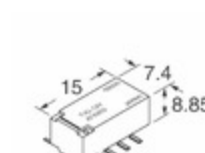
Tags relacionados

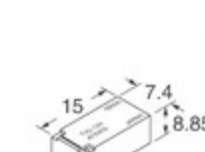
Panasonic TX2SA-L2-24V-1	Distribuidor TX2SA-L2-24V-1	Proveedor TX2SA-L2-24V-1
Precio TX2SA-L2-24V-1	TX2SA-L2-24V-1 Imágenes	Imagen TX2SA-L2-24V-1
Hoja de datos PDF TX2SA-L2-24V-1	Descargar la hoja de datos de TX2SA-L2-24V-1	Hoja de datos TX2SA-L2-24V-1
TX2SA-L2-24V-1 Stock	Comprar TX2SA-L2-24V-1	Comprar Panasonic TX2SA-L2-24V-1
Panasonic TX2SA-L2-24V-1	Proveedor Panasonic	Distribuidor Panasonic
Panasonic TX2SA-L2-24V-1	Panasonic - Consumer Division TX2SA-L2-24V-1	Panasonic - Consumer Electronics Corp. TX2SA-L2-24V-1
Panasonic Battery Group TX2SA-L2-24V-1	Panasonic Electric Works - ACSD TX2SA-L2-24V-1	Panasonic Electronic Components - Semiconductor Pr TX2SA-L2-24V-1
Panasonic - ATG TX2SA-L2-24V-1	Panasonic - BSG TX2SA-L2-24V-1	Panasonic - DTG TX2SA-L2-24V-1
Panasonic Electric Works TX2SA-L2-24V-1	Panasonic Electronic Components TX2SA-L2-24V-1	Panasonic Industrial Automation Sales TX2SA-L2-24V-1
Panasonic Semiconductor TX2SA-L2-24V-1		

Productos relacionados

 <p>TX2SA-L2-12V Fabricantes: Panasonic Descripción: RELAY TELECOM DPDT 2A 220V En stock: 22182 pcs</p> <p>RFQ</p>	 <p>TX2SA-L2-1.5V-Z Fabricantes: Panasonic Descripción: RELAY TELECOM DPDT 2A 220V En stock: 35464 pcs</p> <p>RFQ</p>
 <p>TX2SA-L2-24V-X Fabricantes: Panasonic Descripción: RELAY TELECOM DPDT 2A 220V En stock: 17818 pcs</p> <p>RFQ</p>	 <p>TX2SA-L2-3V-X Fabricantes: Panasonic Descripción: RELAY TELECOM DPDT 2A 220V En stock: 39126 pcs</p> <p>RFQ</p>
 <p>TX2SA-L2-12V-Z Fabricantes: Panasonic Descripción: RELAY TELECOM DPDT 2A 220V En stock: 21093 pcs</p> <p>RFQ</p>	 <p>TX2SA-L2-24V-1-Z Fabricantes: Panasonic Descripción: RELAY TELECOM DPDT 1A 220V En stock: 26479 pcs</p> <p>RFQ</p>
 <p>TX2SA-L2-24V Fabricantes: Panasonic Descripción: RELAY TELECOM DPDT 2A 220V En stock: 18251 pcs</p> <p>RFQ</p>	 <p>TX2SA-L2-12V-X Fabricantes: Panasonic Descripción: RELAY TELECOM DPDT 2A 220V En stock: 31897 pcs</p> <p>RFQ</p>
 <p>TX2SA-L2-12V-1 Fabricantes: Panasonic Descripción: RELAY TELECOM DPDT 1A 220V En stock: 21521 pcs</p> <p>RFQ</p>	 <p>TX2SA-L2-24V-1-X Fabricantes: Panasonic Descripción: RELAY TELECOM DPDT 1A 220V En stock: 28556 pcs</p> <p>RFQ</p>
 <p>TX2SA-L2-3V Fabricantes: Panasonic Descripción: RELAY TELECOM DPDT 2A 220V En stock: 21833 pcs</p> <p>RFQ</p>	 <p>TX2SA-L2-24V-Z Fabricantes: Panasonic Descripción: RELAY TELECOM DPDT 2A 220V En stock: 25319 pcs</p> <p>RFQ</p>

